

Cubes and Rectangular Prisms

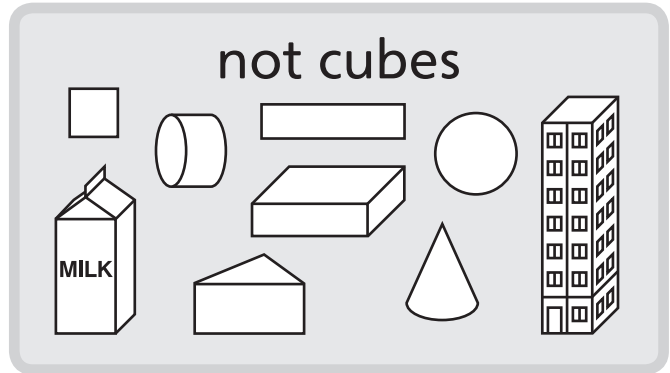

Circle the objects that look like cubes.

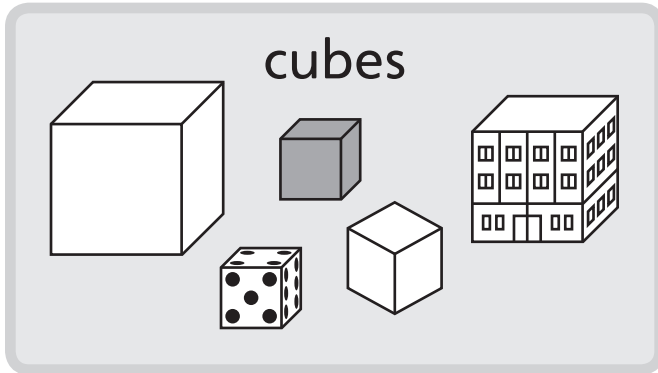
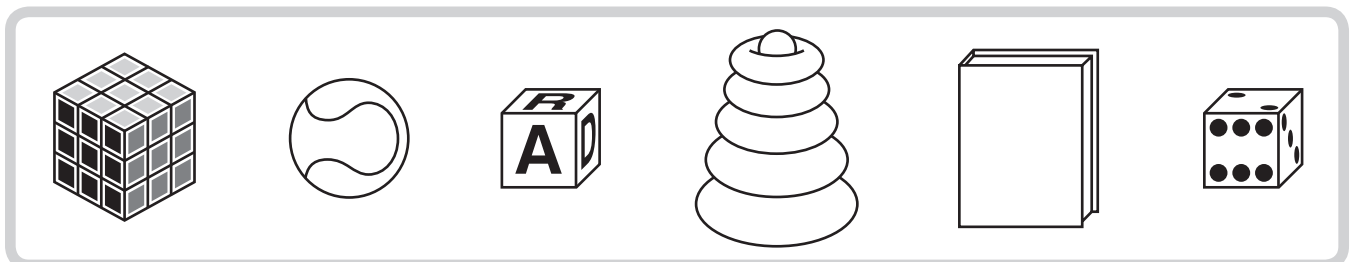
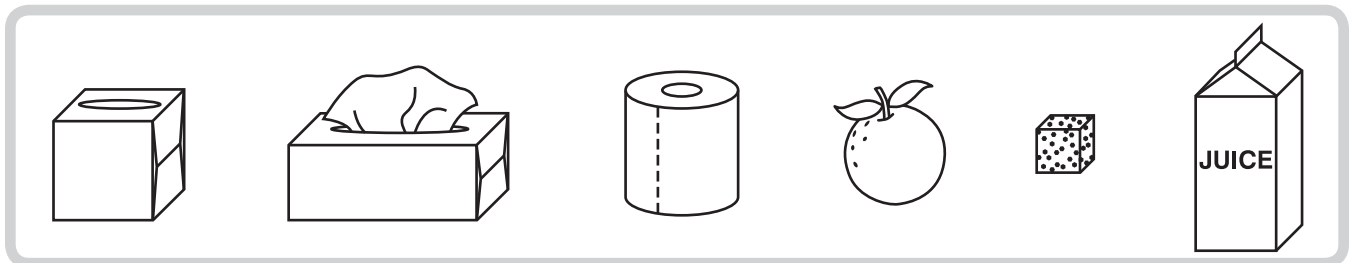
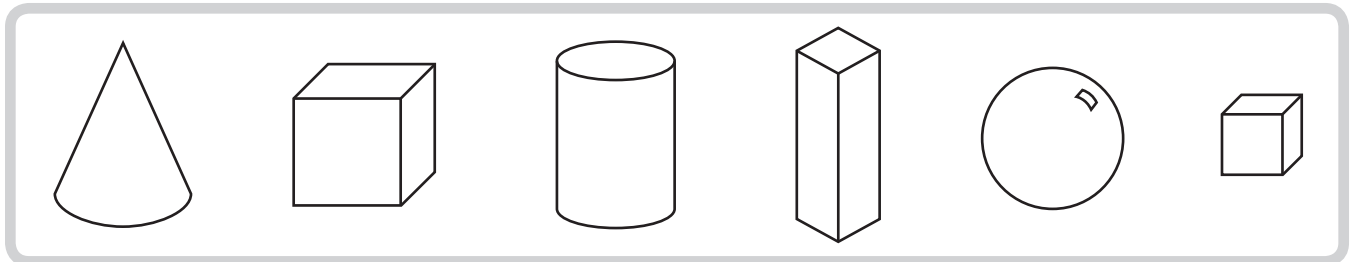

Draw 2 more objects that are almost cubes.

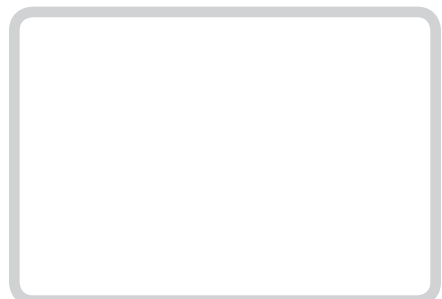
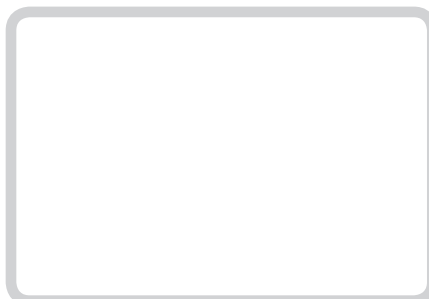
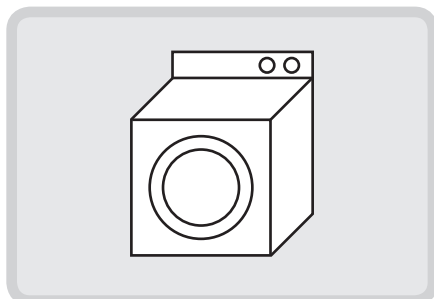

rectangular prisms

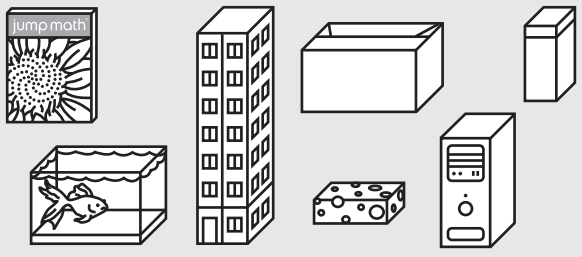

not rectangular prisms

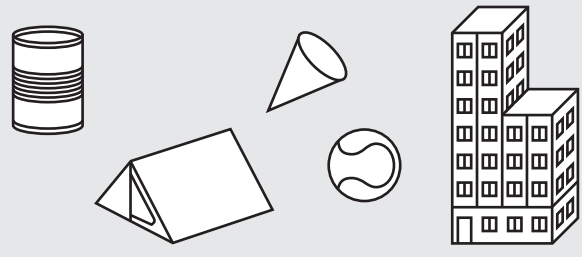

Circle the objects that look like rectangular prisms.

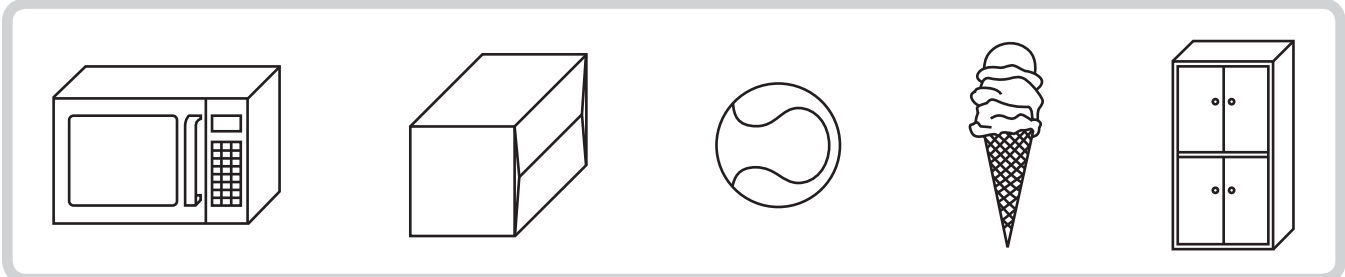
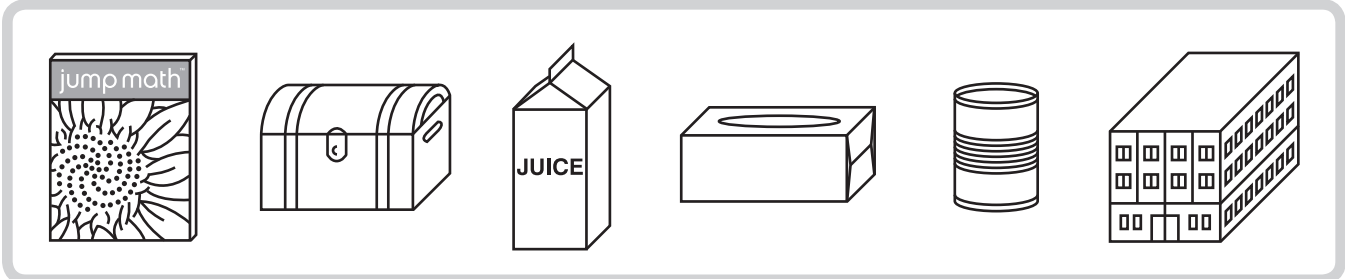
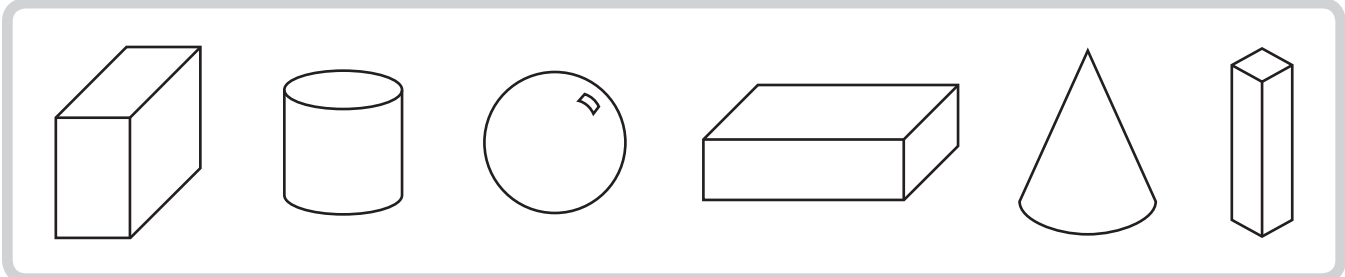

Draw objects that look like rectangular prisms.

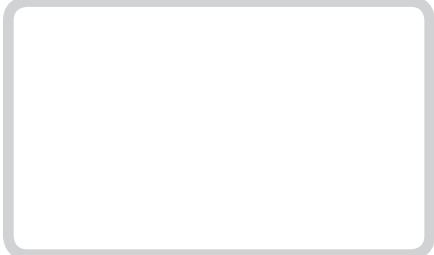
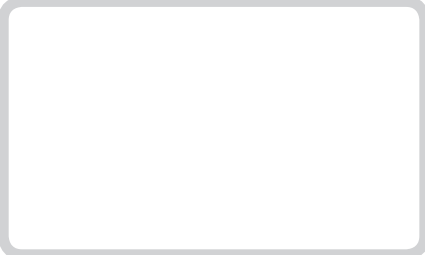
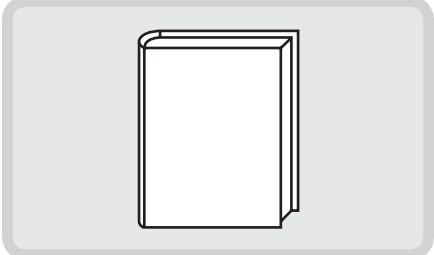

Spheres, Cylinders, and Cones

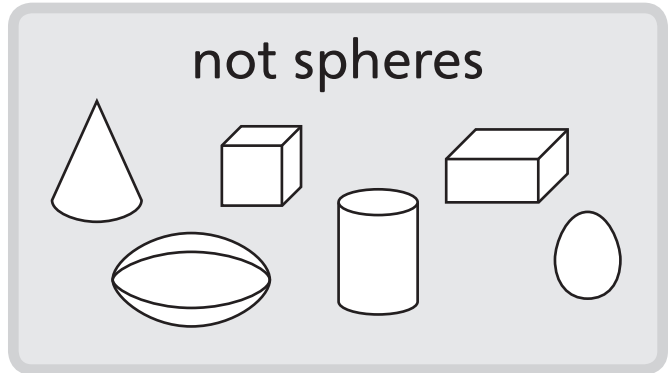
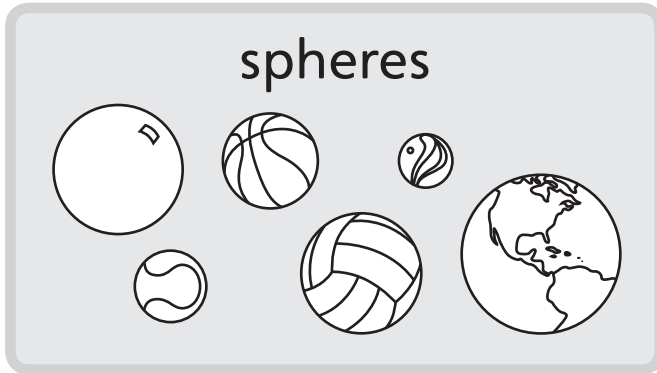

Circle the objects that look like spheres.

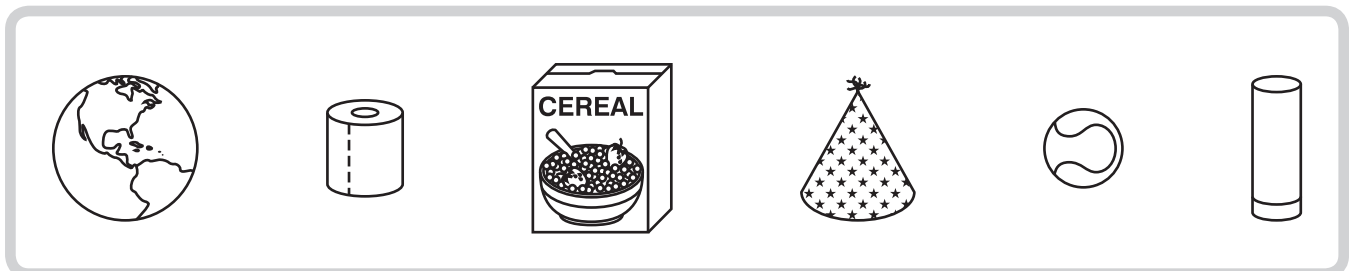
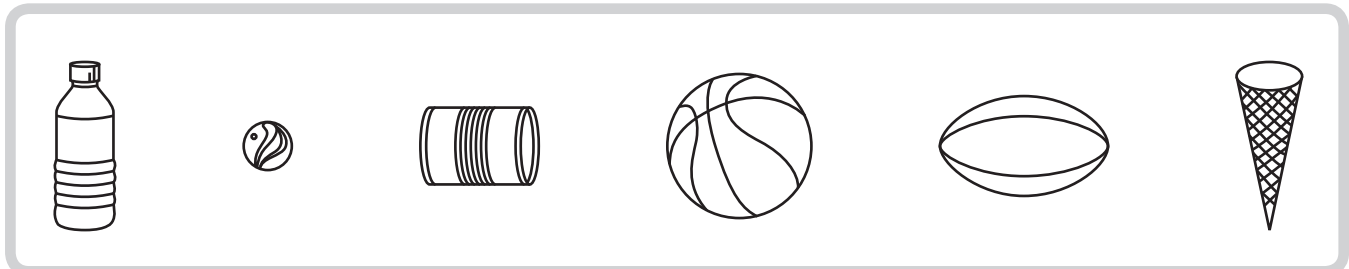
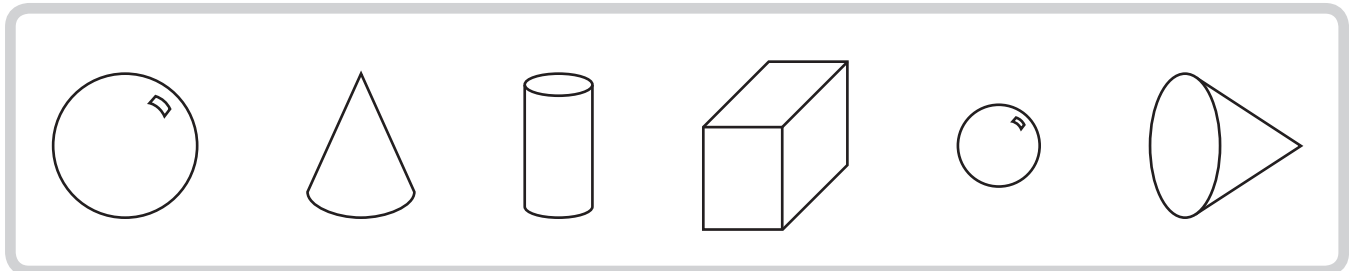

Draw 2 more objects that are almost spheres.



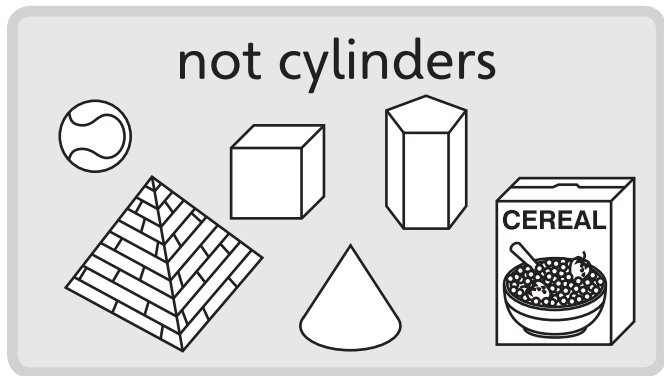
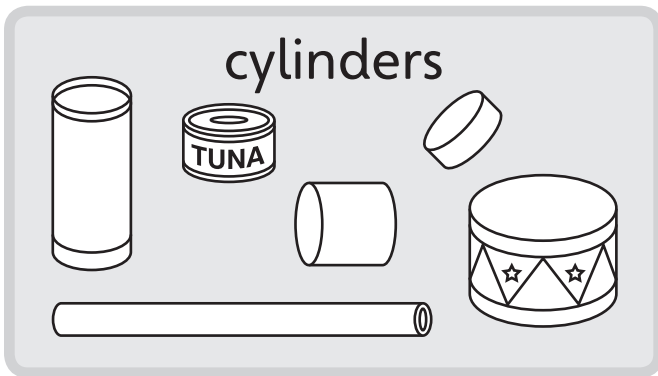

Circle the objects that look like cylinders.

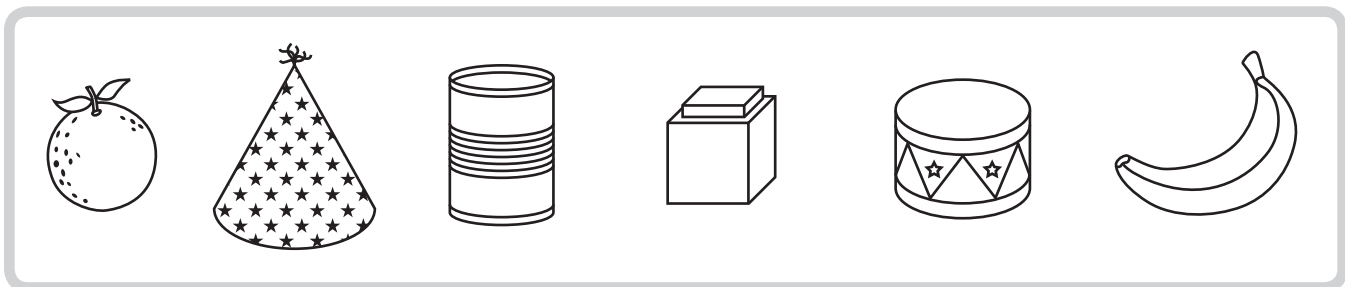
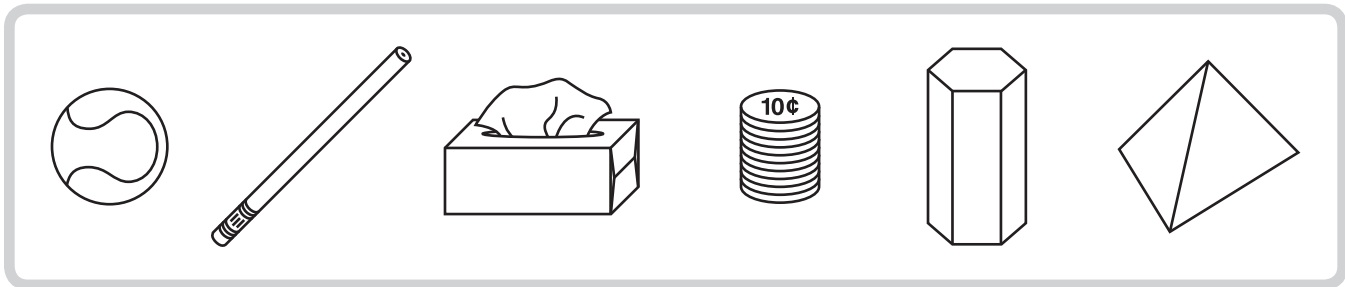
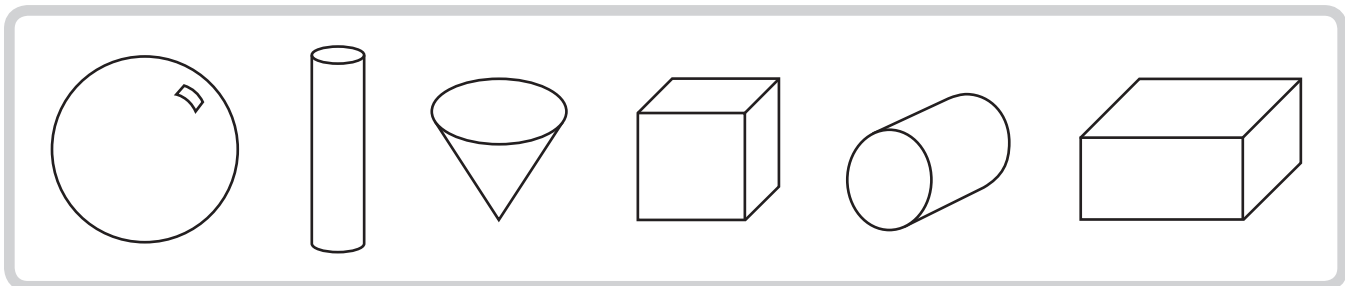

Draw 2 more objects that are almost cylinders.

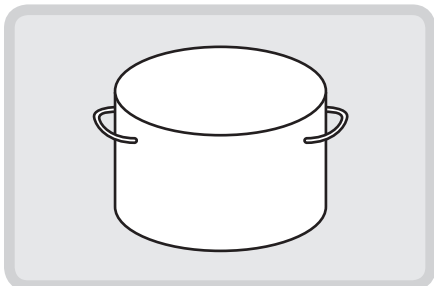

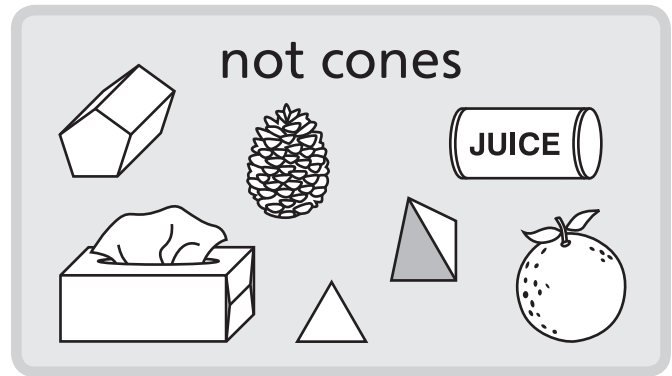
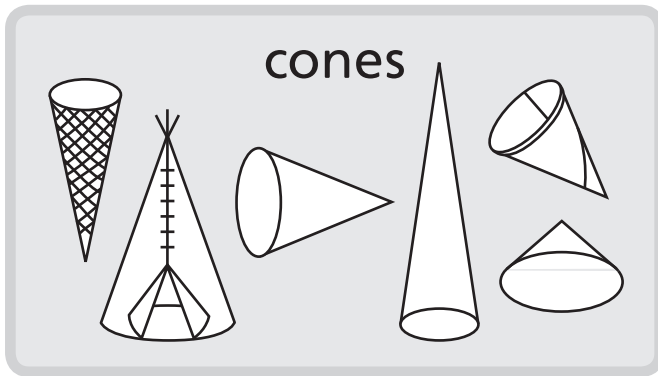

Circle the objects that look like cones.

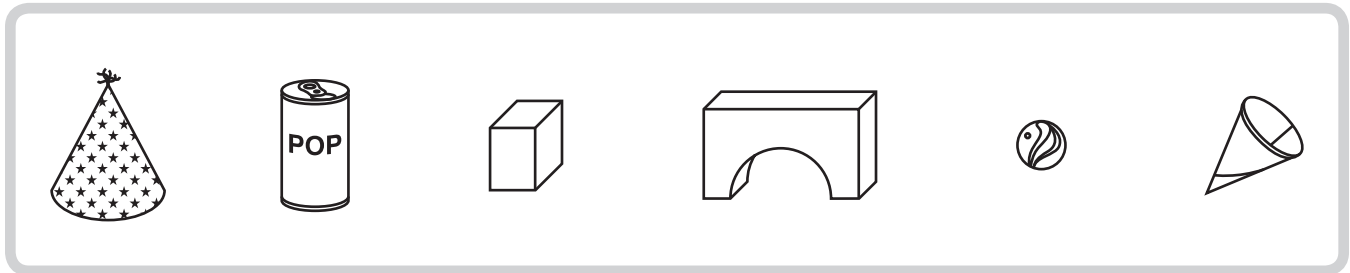
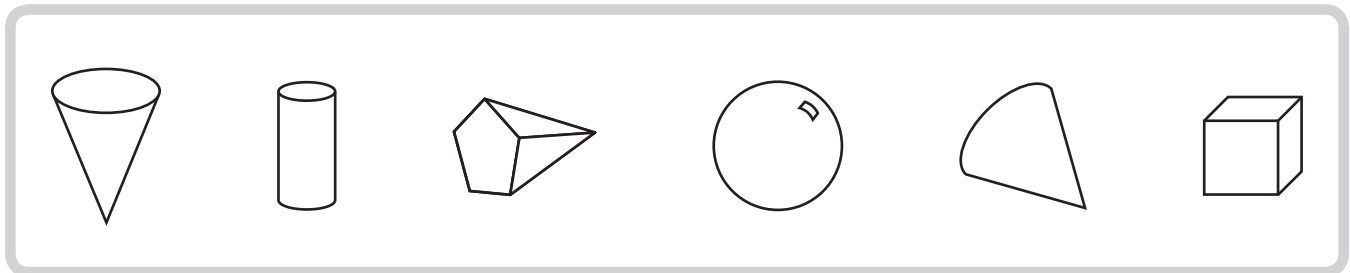

Draw 2 more objects that are almost cones.

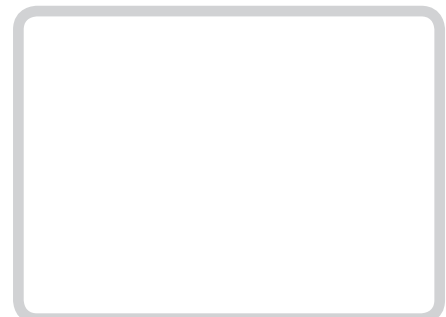
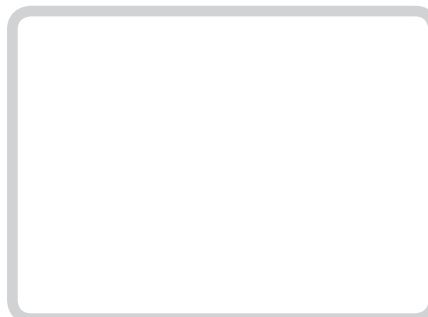
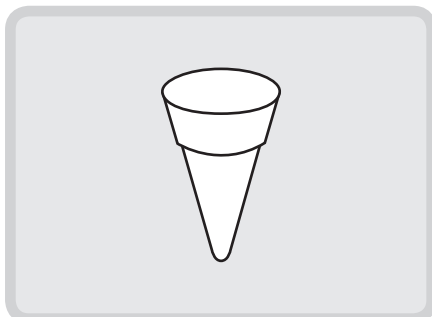

Flat and Curved Faces

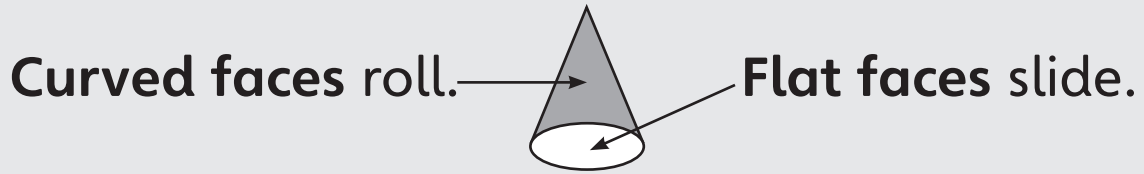

- Colour the **curved faces** orange.
- Colour the **flat faces** blue.

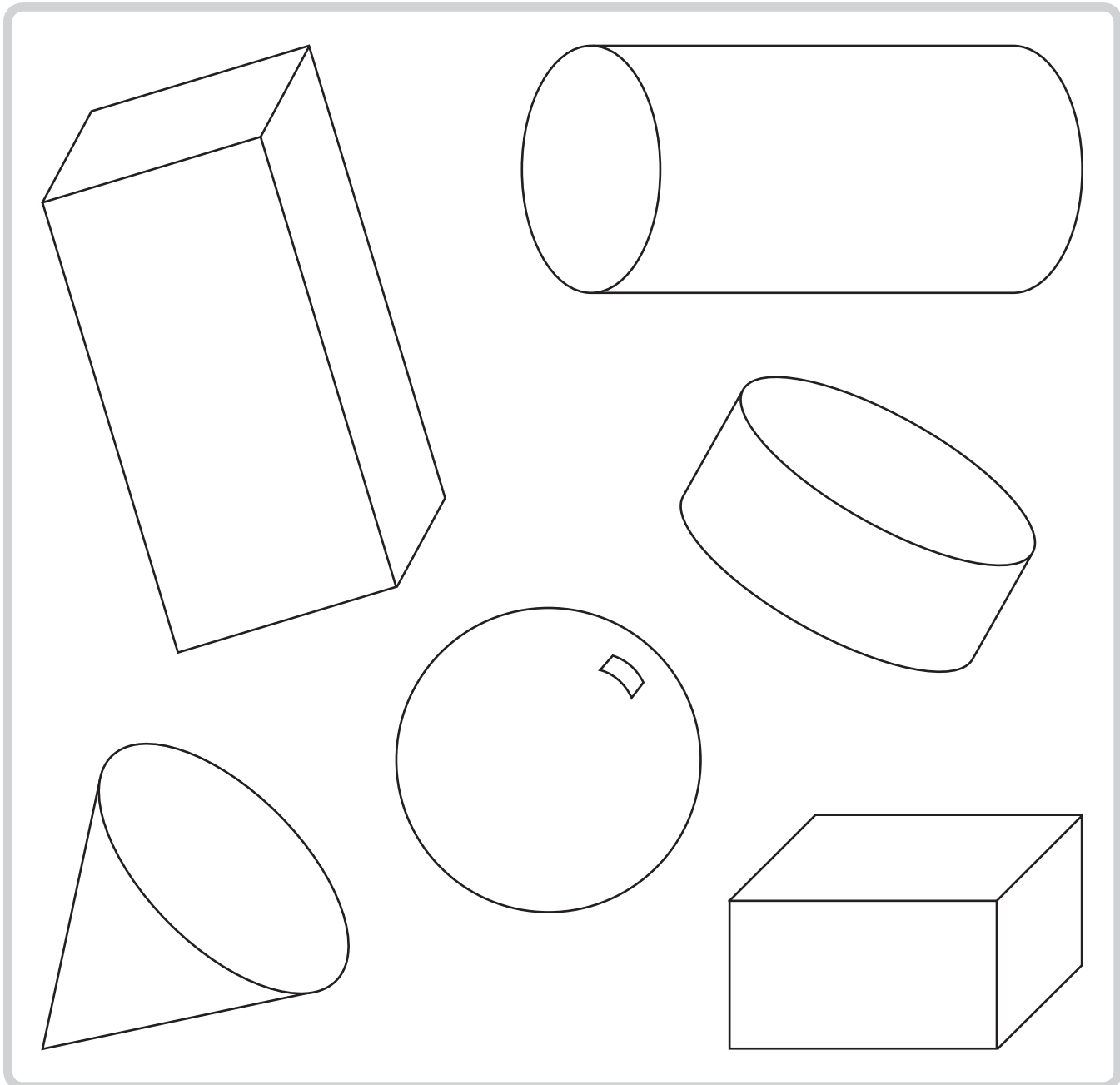

Sort.

has a curved face

has no curved faces



Now sort another way.



has a flat face

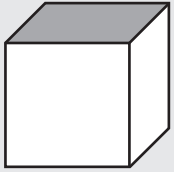
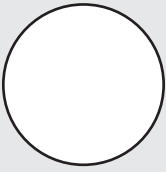
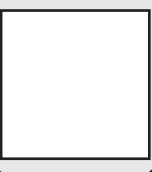
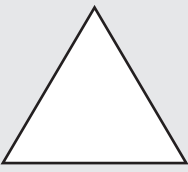

has no flat faces



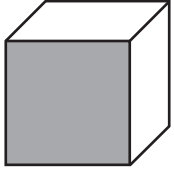
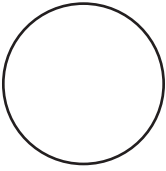
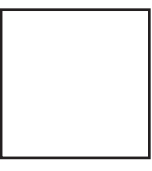
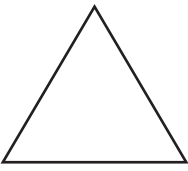

Identifying 3-D Shapes

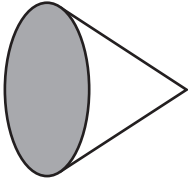
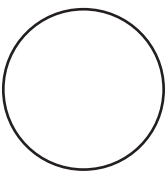
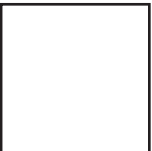
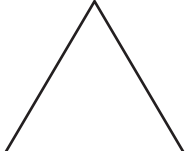

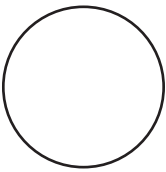

What is the shape of the shaded face? Circle it.

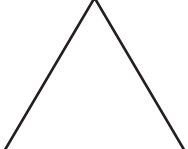

				
---	---	---	---	---

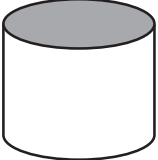
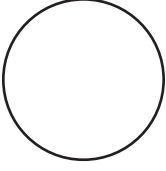
				
---	---	---	---	---

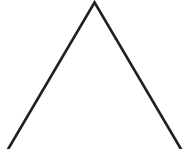
				
--	--	--	--	---

				
---	---	---	---	---

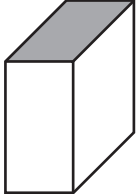
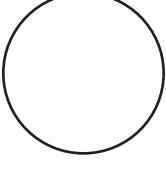
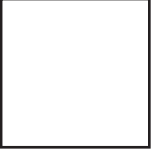
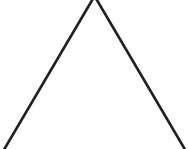
				
---	---	---	---	---

				
---	---	---	---	---

COPYRIGHT © 2017 JUMP MATH. NOT TO BE COPIED

Sort.

has a corner

has no corners

Now sort your way.

cone

cube

cylinder

prism

sphere

Circle the correct shape. Write its name.

I have 6 faces.

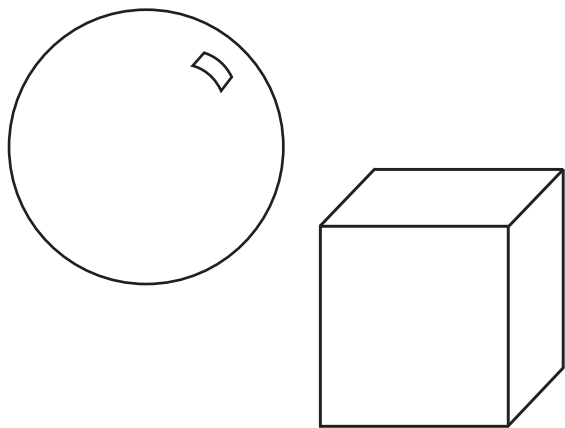

I am a _____.

I have a curved face.

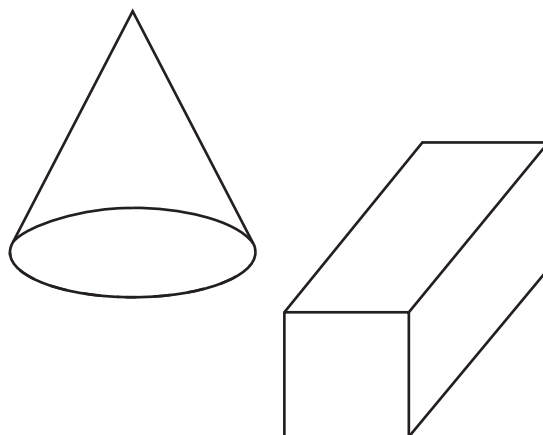

I am a _____.

I have 2 flat faces.

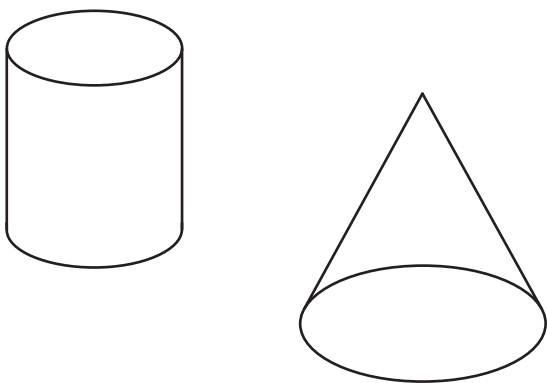

I am a _____.

I roll.

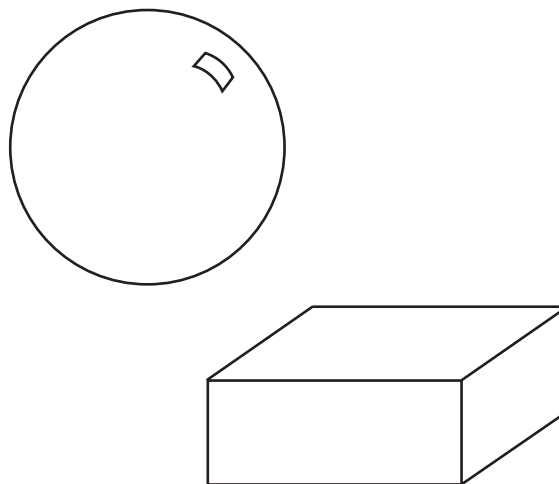

I am a _____.

COPYRIGHT © 2017 JUMP MATH: NOT TO BE COPIED

Composing 3-D Shapes

Colour.

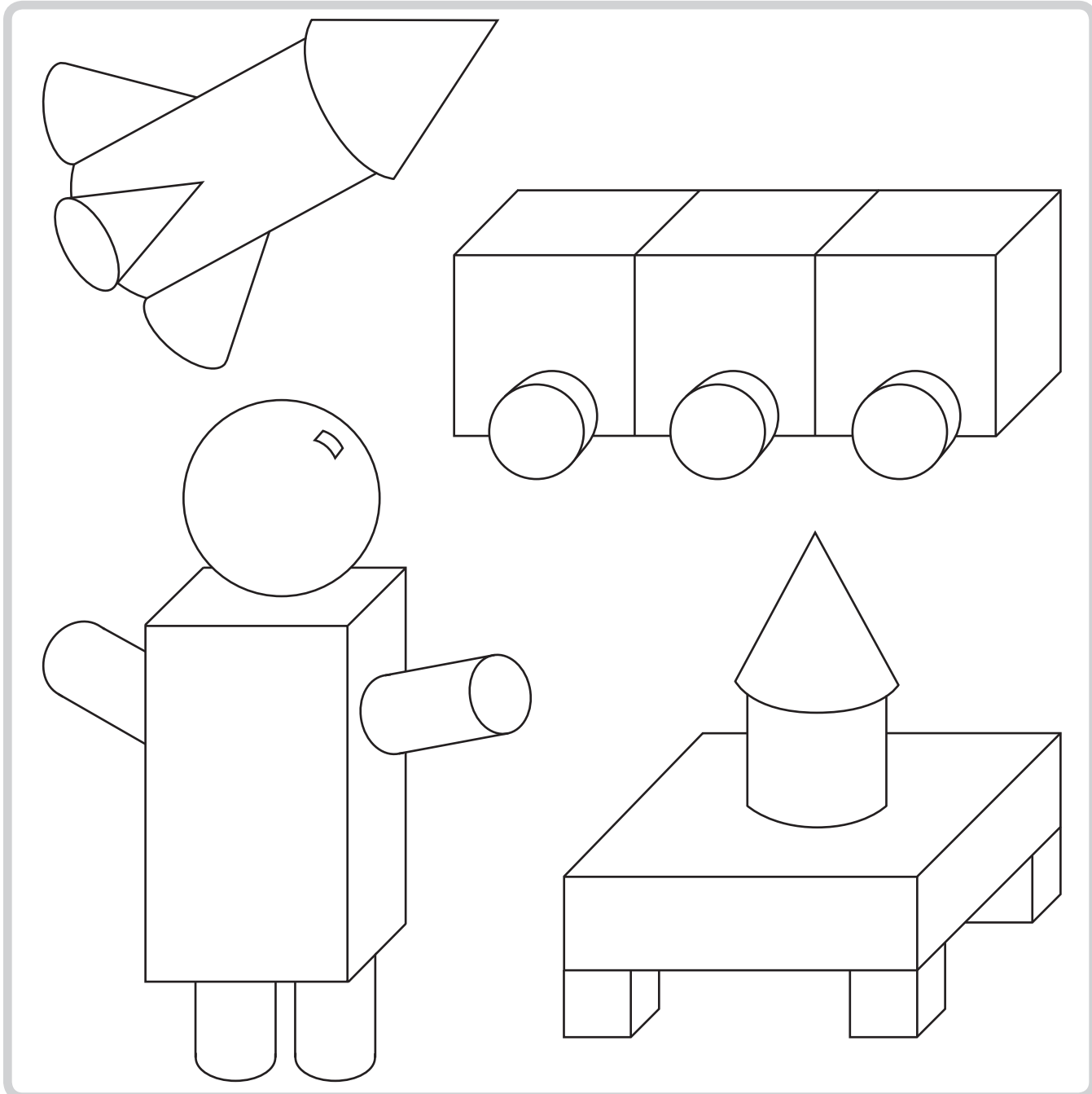
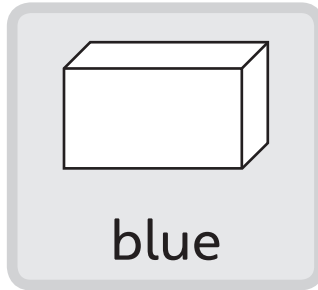
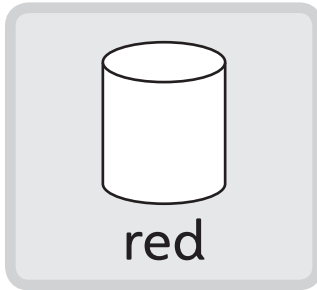
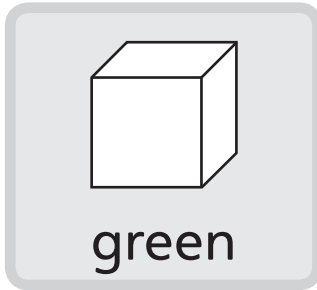
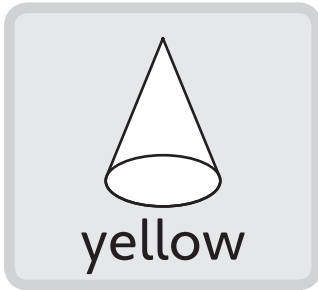

COPYRIGHT © 2017 JUMP MATH: NOT TO BE COPIED

Mandy makes a building from blocks.

Circle the shapes she uses.

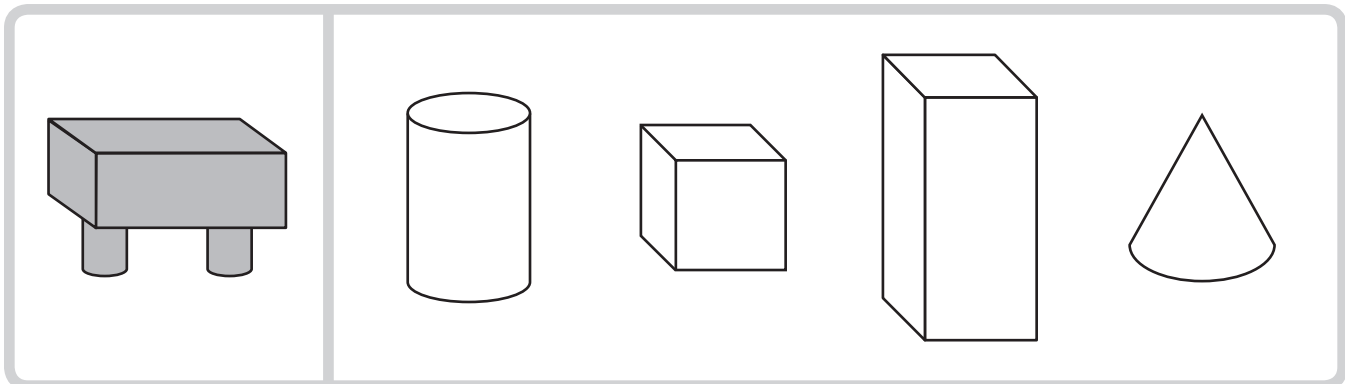
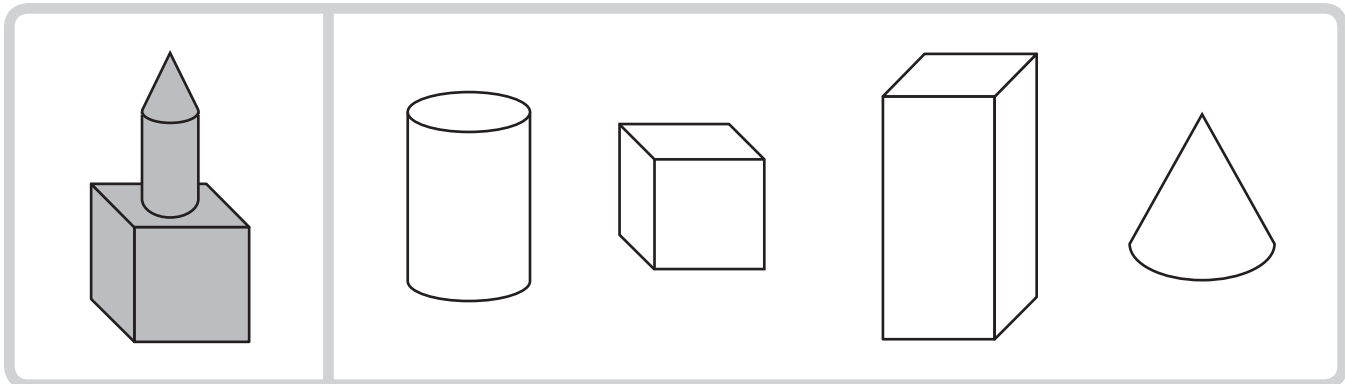
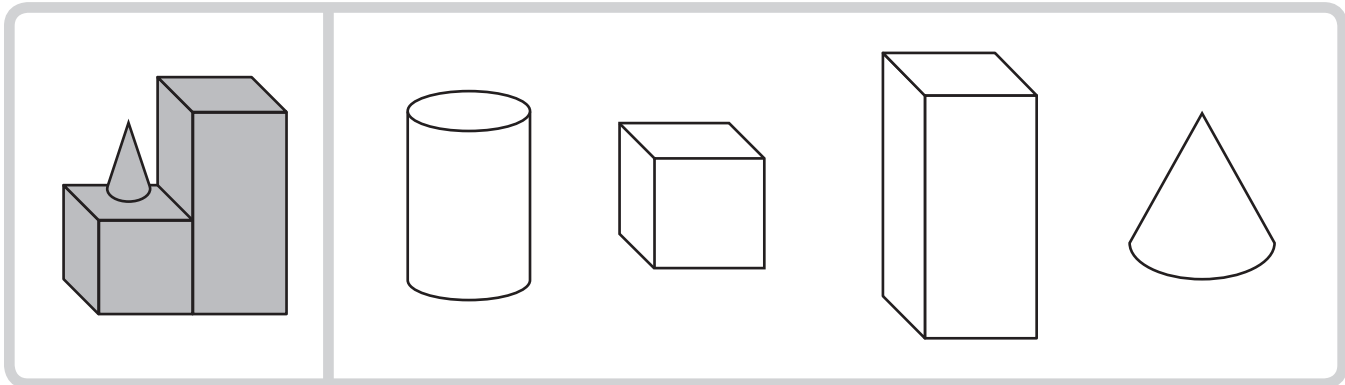
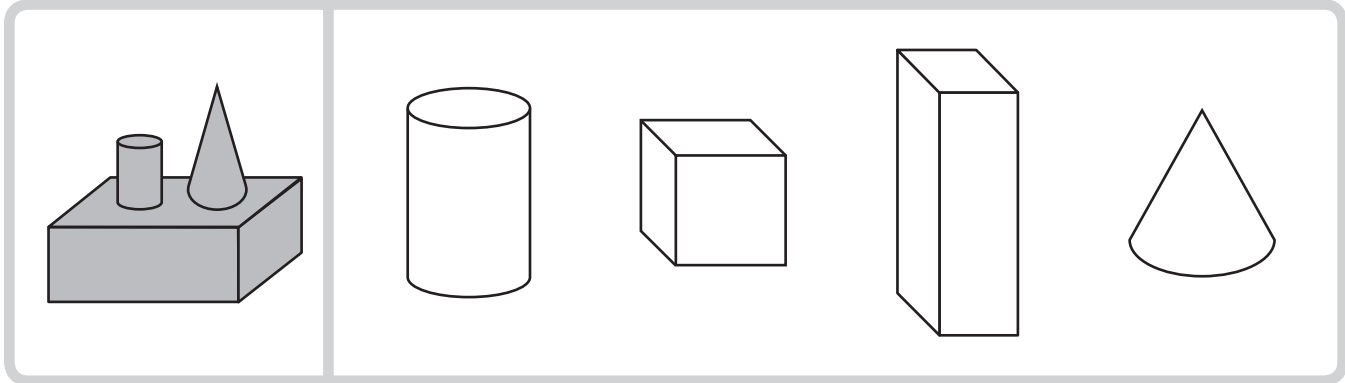

cone

cube

cylinder

prism

sphere



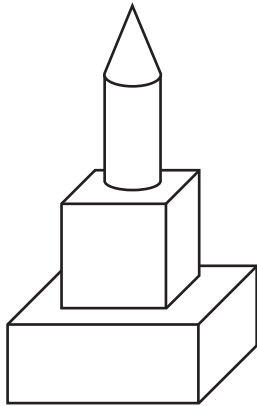

- Write the name beside the shape.
- Fill in the blank.

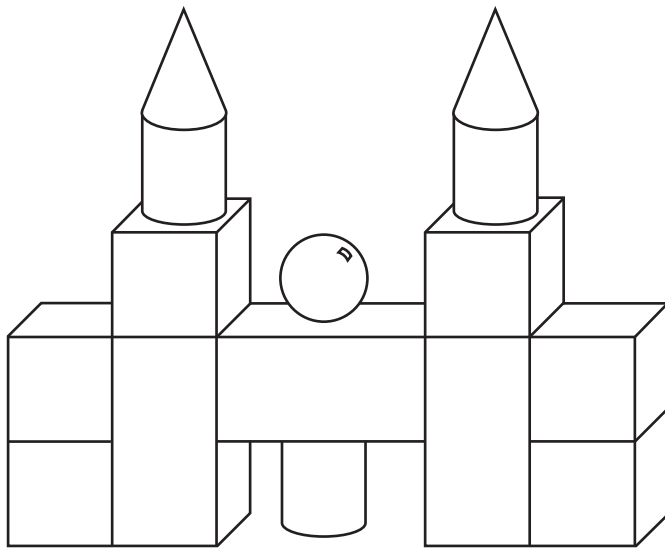

The _____ is not in the tower.

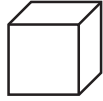
- Write how many.



<u> 3 </u>	
<u> </u>	
<u> </u>	
<u> </u>	
<u> </u>	

Bonus: Build the castle.